

ICE11N70FP N-Channel Enhancement Mode MOSFET

Features

- Low $r_{DS(on)}$
- Ultra Low Gate Charge
- High dv/dt capability
- High Unclamped Inductive Switching (UIS) capability
- High peak current capability
- Increased transconductance performance
- Optimized design for high performance power systems

Product Summary			
I_D	$T_c=25^\circ\text{C}$	11A	Max
$V_{(BR)DSS}$	$I_D=250\mu\text{A}$	700V	Min
$r_{DS(on)}$	$V_{GS}=10\text{V}$	0.24 Ω	Typ
Q_g	$V_{DS}=480\text{V}$	81nC	Typ

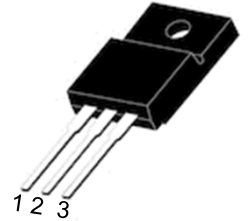
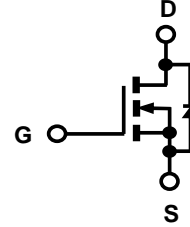

Lead Free

T0220FP

Isolated (T0-220)

1=Gate, 2=Drain,
3=Source.

ICEMOS AND ITS SISTER COMPANY 3D SEMI OWN THE FUNDAMENTAL PATENTS FOR SUPERJUNCTION MOSFETS. THE MAJORITY OF THESE PATENTS HAVE 17 TO 20 YEARS OF REMAINING LIFE. THIS PORTFOLIO HAS GRANTED PATENTS ISSUED IN USA, CHINA, KOREA, JAPAN, TAIWAN & EUROPE.

Maximum ratings^b at $T_j=25^\circ\text{C}$, unless otherwise specified

Parameter	Symbol	Conditions	Value	Unit
Continuous drain current	I_D	$T_c=25^\circ\text{C}$	11	A
		$T_c=100^\circ\text{C}$	4.4	
Pulsed drain current	$I_{D, pulse}$	$T_c=25^\circ\text{C}$	35	A
Avalanche energy, single pulse	E_{AS}	$I_D=5\text{A}$	125	mJ
Avalanche current, repetitive	I_{AR}	limited by T_{jmax}	5	A
MOSFET dv/dt ruggedness	dv/dt	$V_{DS}=480\text{V}$, $I_D=11\text{A}$, $T_j=125^\circ\text{C}$	50	V/ns
Gate source voltage	V_{GS}	Static	± 20	V
		AC ($f>1\text{Hz}$)	± 30	
Power dissipation	P_{tot}	$T_c=25^\circ\text{C}$	35	W
Operating and storage temperature	T_j, T_{stg}		-55 to +150	$^\circ\text{C}$
Mounting torque		M 3 screws	50	Ncm

a When mounted on 1inch square 2oz copper clad FR-4

b limited by T_{jmax}

Parameter	Symbol	Conditions	Values			Unit
			Min	Typ	Max	
Thermal characteristics						
Thermal resistance, junction-case ^a	R_{thJC}		-	-	3.5	°C/W
Thermal resistance, junction-ambient ^a	R_{thJA}	leaded	-	-	72	
Soldering temperature, wave soldering only allowed at leads	T_{sold}	1.6mm (0.063in.) from case for 10 s	-	-	260	°C

Electrical characteristics at $T_j=25^\circ\text{C}$, unless otherwise specified

Static characteristics

Drain-source breakdown voltage	$V_{(BR)DSS}$	$V_{GS}=0\text{ V}, I_D=250\mu\text{A}$	700	760	-	V
Gate threshold voltage	$V_{GS(th)}$	$V_{DS}=V_{GS}, I_D=250\mu\text{A}$	2.5	3.1	3.5	
Zero gate voltage drain current	I_{DSS}	$V_{DS}=700\text{V}, V_{GS}=0\text{V}, T_j=25^\circ\text{C}$	-	0.1	1	μA
		$V_{DS}=700\text{V}, V_{GS}=0\text{V}, T_j=150^\circ\text{C}$	-	100	-	
Gate source leakage current	I_{GSS}	$V_{GS}=\pm 20\text{ V}, V_{DS}=0\text{V}$	-	-	100	nA
Drain-source on-state resistance	$R_{DS(on)}$	$V_{GS}=10\text{V}, I_D=5.5\text{A}, T_j=25^\circ\text{C}$	-	0.24	0.27	Ω
		$V_{GS}=10\text{V}, I_D=5.5\text{A}, T_j=150^\circ\text{C}$	-	0.66	-	
Gate resistance	R_G	$f=1\text{ MHz}, \text{open drain}$	-	3.0	-	Ω

Dynamic characteristics

Input capacitance	C_{iss}	$V_{GS}=0\text{ V}, V_{DS}=100\text{ V}, f=1\text{ MHz}$	-	2816	-	μF
Output capacitance	C_{oss}		-	106	-	
Reverse transfer capacitance	C_{rss}		-	0.4	-	
Transconductance	g_{fs}	$V_{DS}>2 \cdot I_D \cdot R_{DS}, I_D=5.5\text{A}$	-	13	-	S
Turn-on delay time	$t_{d(on)}$	$V_{DS}=380\text{V}, V_{GS}=10\text{V}, I_D=5.5\text{A}, R_G=4\Omega$ (External)	-	38	-	ns
Rise time	t_r		-	12	-	
Turn-off delay time	$t_{d(off)}$		-	131	-	
Fall time	t_f		-	11	-	

Parameter	Symbol	Conditions	Values			Unit
			Min	Typ	Max	

Gate charge characteristics

Gate to source charge	Q_{gs}	$V_{DS}=480\text{ V}, I_D=11\text{ A},$ $V_{GS}=0\text{ to }10\text{ V}$	-	14	-	nC
Gate to drain charge	Q_{gd}		-	29	-	
Gate charge total	Q_g		-	81	-	
Gate plateau voltage	$V_{plateau}$		-	5.2	-	V

Reverse Diode

Continuous forward current	I_S	$V_{GS}=0\text{ V}$	-	-	11	A
Diode forward voltage	V_{SD}	$V_{GS}=0\text{ V}, I_S=I_F$	-	1.0	1.2	V
Reverse recovery time	t_{rr}	$V_{RR}=50\text{ V}, I_S=I_F,$ $d_{iF}/d_t=100\text{ A}/\mu\text{S}$	-	383	-	ns
Reverse recovery charge	Q_{rr}		-	7.0	-	μC
Peak reverse recovery current	I_{rm}		-	33	-	A

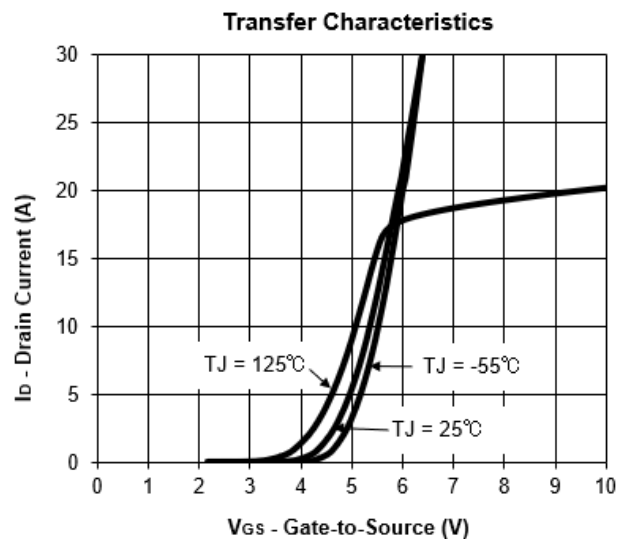
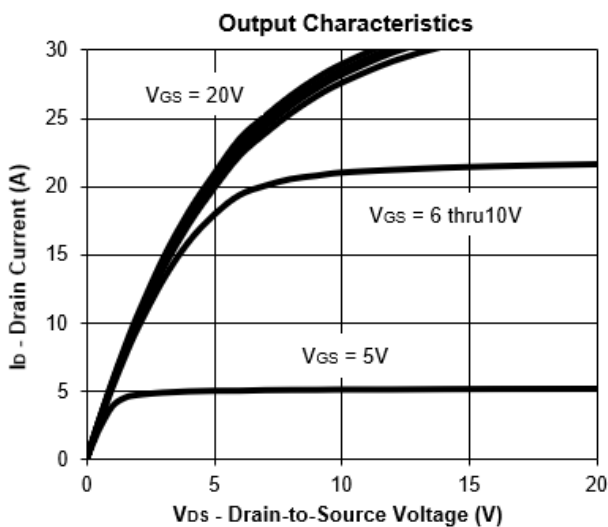

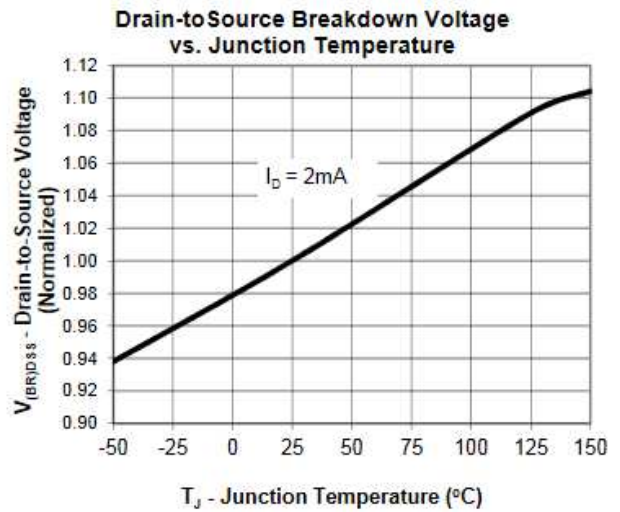
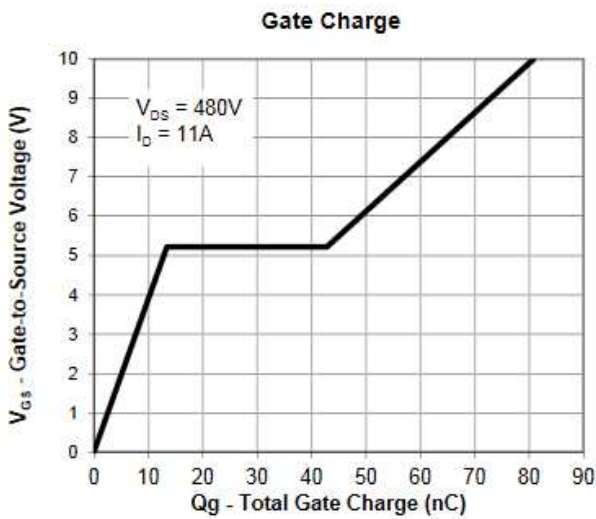
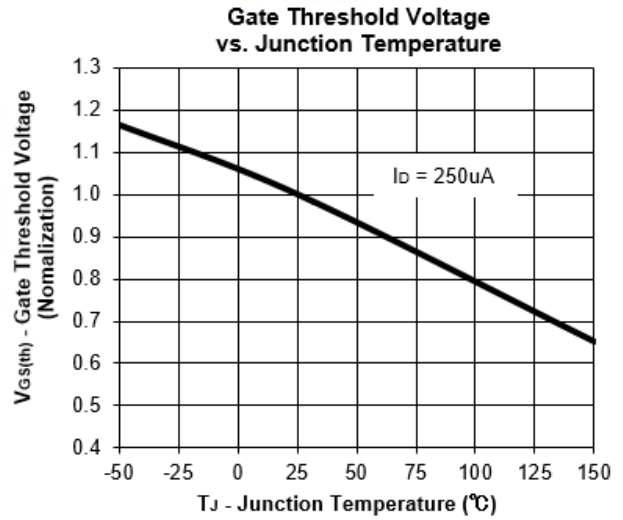
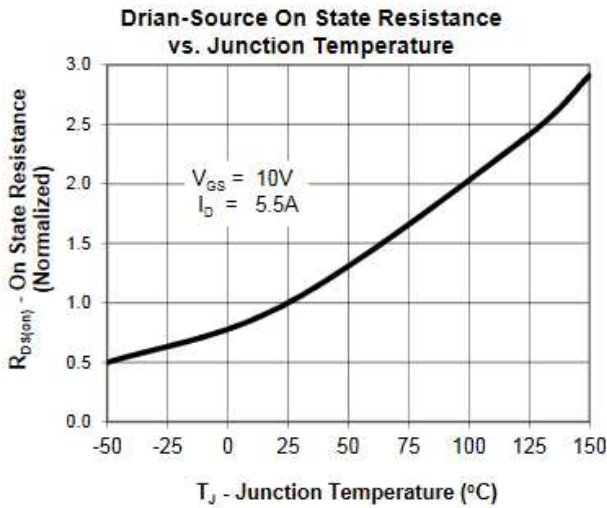
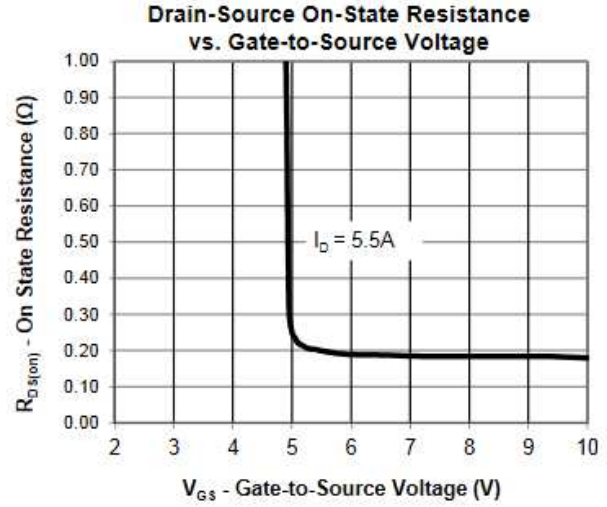
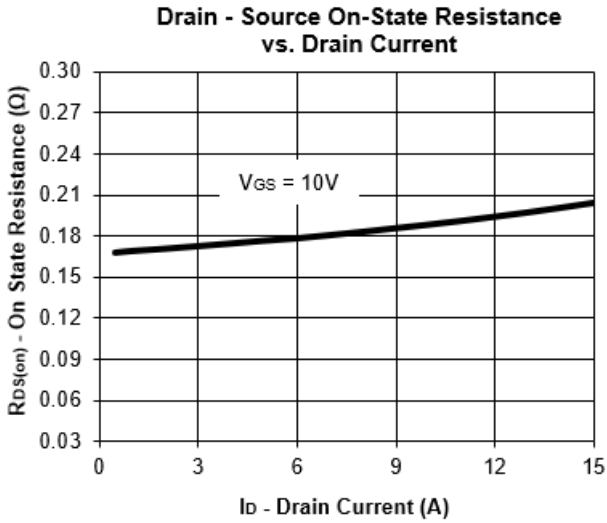

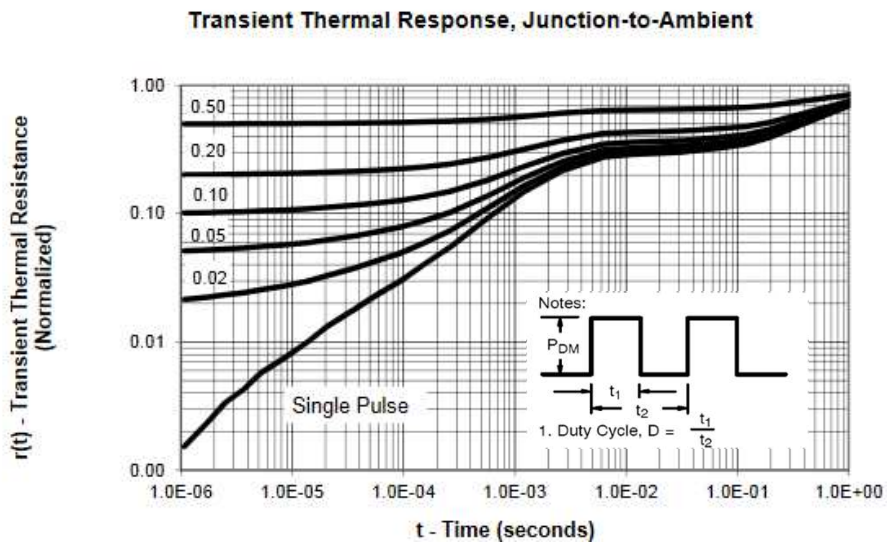
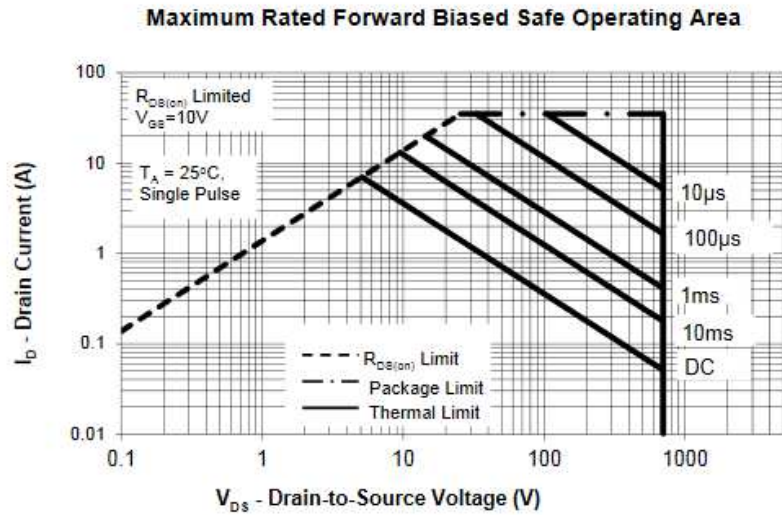
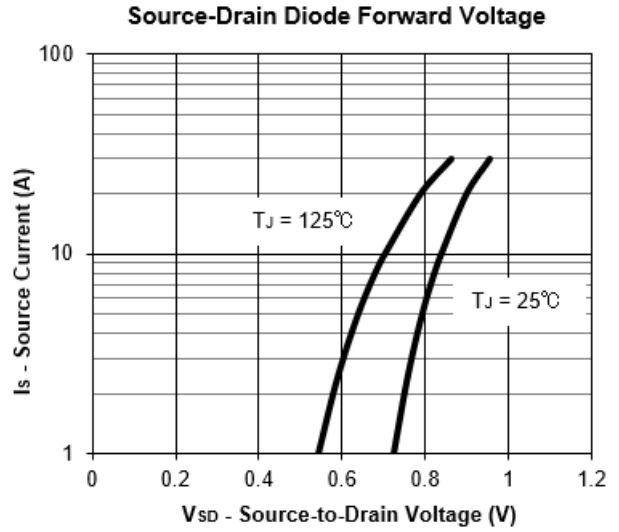
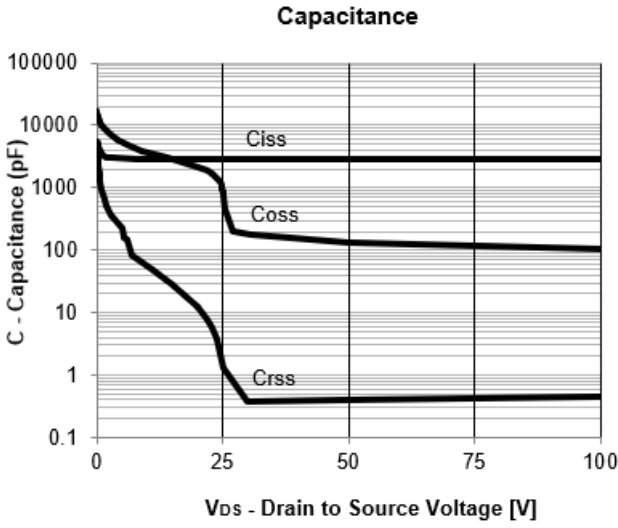

Package Outline: TO-220 FullPAK

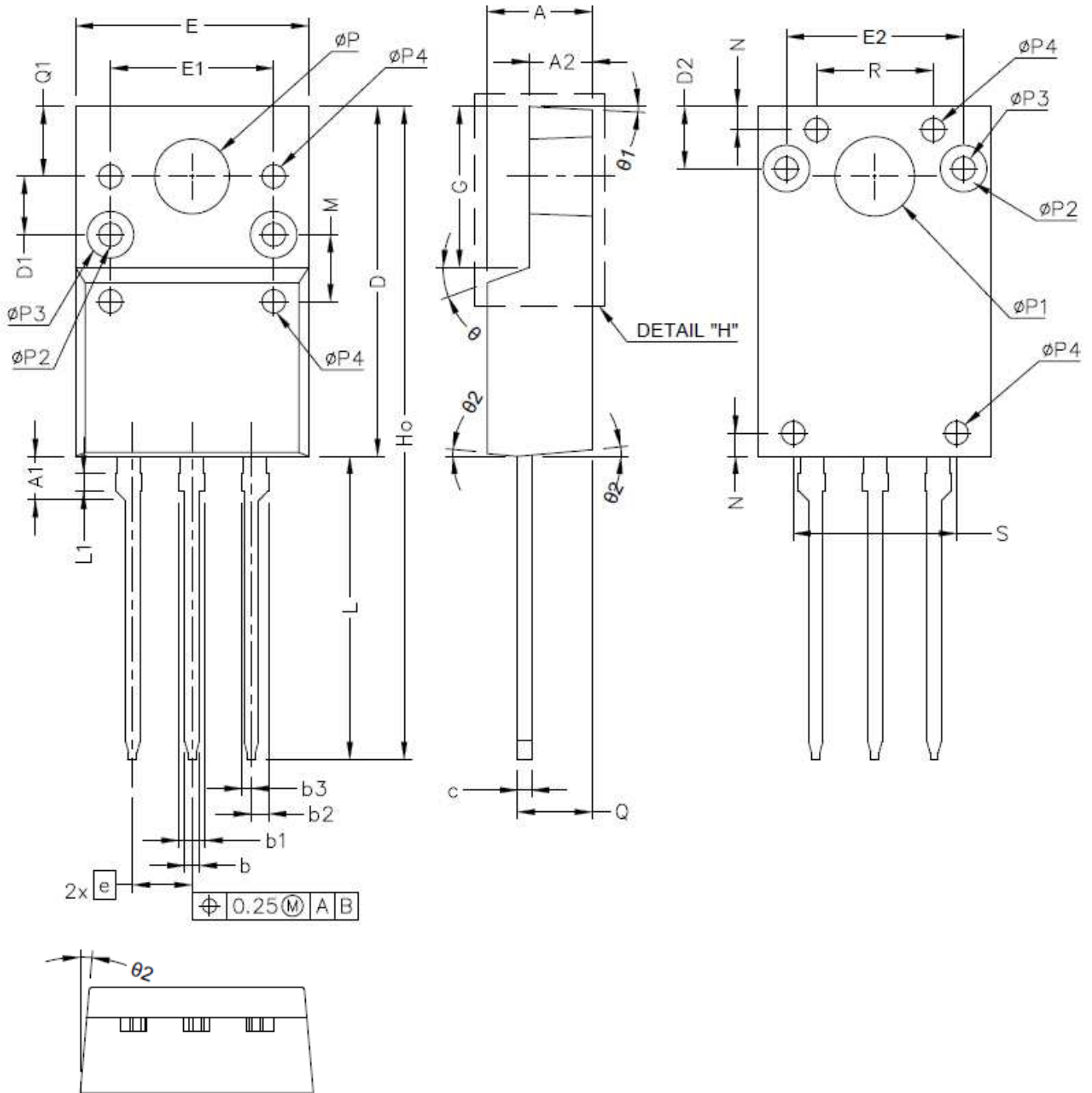

Package Outline: TO-220 FullPAK

NOTE :

- 1). ALL METAL SURFACES: TIN PLATED, EXCEPT AREA OF CUT
2. DIMENSIONING & TOLERANCEING CONFIRM TO ASME Y14.5M-1994.
3. ALL DIMENSIONS ARE IN MILLIMETERS. ANGLES ARE IN DEGREES.
4. RADIUS ON TERMINAL IS OPTIONAL.
5. GENERAL TOLERANCES - LINEAR ± 0.05
6. PLASTIC BODY FINISHIN: MATT FINISHING $R_a=1.5\sim 1.7$ MICRONS
7. MISMATCH MAX. = 0.05 (CAVITY TO HOLE AXIS)}
8. (x) SHOULDER WIDTH TOLERANCE INCLUSIVE OF CUTTING PROTRUSION.

SYMBOL	MIN	MAX	SYMBOL	MIN	MAX
A	4.30	4.70	L1	0.70	0.90
A1	1.80	2.10	M	(2.86)	
A2	2.50	2.90	N	(1.00)	
b	0.54	0.84	ϕP	3.05	3.40
b1	0.99	1.29	$\phi P1$	(3.40)	
b2	0.56	0.93	$\phi P2$	(1.00)	
b3	0.24	0.55	$\phi P3$	(2.00)	
c	0.49	0.79	$\phi P4$	(1.00)	
D	14.70	15.30	Q	3.10	3.30
D1	(2.50)		Q1	2.70	3.30
D2	(2.66)		R	(5.00)	
e	2.29	2.79	S	(7.00)	
E	9.70	10.30	θ	(20°)	
E1	(7.00)		$\theta 1$	(3°)	
E2	(7.60)		$\theta 2$	(5°)	
G	6.70	7.10			
Ho	(28.00)				
L	12.50	13.50			

ICEMOS SUPERJUNCTION PATENT PORTFOLIO

ICEMOS GRANTED PATENTS

US7,429,772

US7,439,178

US7,446,018

US7,579,607

US7,723,172

US7,795,045

US7,846,821

US7,944,018

US8,012,806

US8,030,133

3D SEMI PATENTS LICENSED TO ICEMOS

US7,041,560B2

US7,023,069B2

US7,364,994

US7,227,197B2

US7,304,944B2

US7,052,982B2

US7,339,252

US7,410,891

US7,439,583

US7,227,197B2

US6,635,906

US6,936,867

US7,015,104

US9,109,110

US7,271,067

US7,354,818

US7,052,982,

US7,199,006B2

Note: additional patents in China, Korea, Japan, Taiwan, Europe have also been granted to IceMOS and 3D Semi for Superjunction MOSFETs with 70 additional Patent applications in process in the USA and the above listed countries.

Marking Information

YY = Last two digits of the year

WW = Work week

***** = Site ID

XXXXX = Lot ID

ICE11N70 = ICE is IceMOS logo and
11N70 is a designated device part
number

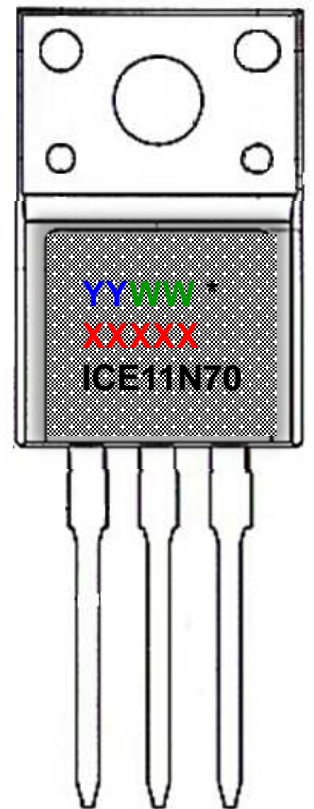

Disclaimer

Information contained in this data sheet shall in no event be regarded as a guarantee of conditions or characteristics. All product, data sheet are subject to change without notice to improve reliability. ICEMOS technology will not be responsible for damages of any nature resulting from the use or reliance upon the information contained in this data sheet.